

CENTRAL PNEUMATIC®

THREE GALLON OILLESS AIR COMPRESSOR

Model 95275

SET UP AND OPERATING INSTRUCTIONS



Visit our website at: <http://www.harborfreight.com>



**Read this material before using this product.
Failure to do so can result in serious injury.
SAVE THIS MANUAL.**

Copyright© 2006 by Harbor Freight Tools®. All rights reserved. No portion of this manual or any artwork contained herein may be reproduced in any shape or form without the express written consent of Harbor Freight Tools. Diagrams within this manual may not be drawn proportionally. Due to continuing improvements, actual product may differ slightly from the product described herein. Tools required for assembly and service may not be included.

For technical questions or replacement parts, please call 1-800-444-3353.

SAVE THIS MANUAL

Keep this manual for the safety warnings and precautions, assembly, operating, inspection, maintenance and cleaning procedures. Write the product's serial number in the back of the manual near the assembly diagram (or month and year of purchase if product has no number). Keep this manual and the receipt in a safe and dry place for future reference.

IMPORTANT SAFETY INFORMATION

In this manual, on the labeling, and all other information provided with this product:



This is the safety alert symbol. It is used to alert you to potential personal injury hazards. Obey all safety messages that follow this symbol to avoid possible injury or death.

DANGER

DANGER indicates a hazardous situation which, if not avoided, will result in death or serious injury.

WARNING

WARNING indicates a hazardous situation which, if not avoided, could result in death or serious injury.

CAUTION

CAUTION, used with the safety alert symbol, indicates a hazardous situation which, if not avoided, could result in minor or moderate injury.

NOTICE

NOTICE is used to address practices not related to personal injury.

CAUTION

CAUTION, without the safety alert symbol, is used to address practices not related to personal injury.

General Safety Warnings



WARNING Read all safety warnings and instructions. *Failure to follow the warnings and instructions may result in electric shock, fire and/or serious injury.*

Save all warnings and instructions for future reference.

1. **Work area safety**
 - a. **Keep work area clean and well lit.** Cluttered or dark areas invite accidents.
 - b. **Do not operate the Compressor in explosive atmospheres, such as in the presence of flammable liquids, gases or dust.** Compressor motors produce sparks which may ignite the dust or fumes.
 - c. **Keep children and bystanders away from an operating compressor.**
2. **Electrical safety**
 - a. **Compressor plugs must match the outlet. Never modify the plug in any way. Do not use any adapter plugs with grounded compressors.** Standard plugs and matching outlets will reduce risk of electric shock.
 - b. **Do not expose compressor to rain or wet conditions.** Water entering a compressor will increase the risk of electric shock.
 - c. **Do not abuse the cord. Never use the cord for unplugging the compressor. Keep cord away from heat, oil, sharp edges or moving**

REV 10b

parts. Damaged or entangled cords increase the risk of electric shock.

3. **Personal safety**

- a. **Stay alert, watch what you are doing and use common sense when operating this compressor. Do not use this compressor while you are tired or under the influence of drugs, alcohol or medication.** A moment of inattention while operating a compressor may result in serious personal injury.
- b. **Use personal protective equipment. Always wear ANSI-approved eye protection during setup and use.**
- c. **Prevent unintentional starting. Ensure the switch is in the off-position before connecting to power source or moving the compressor.**

4. **Compressor use and care**

- a. **Do not use the compressor if the switch does not turn it on and off.** Any compressor that cannot be controlled with the switch is dangerous and must be repaired.
- b. **Disconnect the plug from the power source before making any adjustments, changing accessories, or storing the compressor.** Such preventive safety measures reduce the risk of starting the compressor accidentally.
- c. **Store an idle compressor out of the reach of children and do not allow persons unfamiliar with the compressor or these instructions to operate it.** A compressor is dangerous in the hands of untrained users.
- d. **Maintain the compressor. Keep the compressor clean for better and safer performance. Follow instructions for lubricating and changing accessories. Keep dry,**

clean and free from oil and grease. Check for misalignment or binding of moving parts, breakage of parts and any other condition that may affect the compressor's operation. If damaged, have the compressor repaired before use. Many accidents are caused by a poorly maintained compressor.

- e. **Use the compressor in accordance with these instructions, taking into account the working conditions and the work to be performed.** Use of the compressor for operations different from those intended could result in a hazardous situation.

5. **Service**

- a. **Have your compressor serviced by a qualified repair person using only identical replacement parts.** This will ensure that the safety of the compressor is maintained.

Air Compressor Safety Warnings

- 1. **Risk of fire or explosion - do not spray flammable liquid in a confined area or towards a hot surface.** Spray area must be well-ventilated. Do not smoke while spraying or spray where spark or flame is present. Arcing parts - keep compressor at least 20 feet away from explosive vapors, such as when spraying with a spray gun.
- 2. **Risk of bursting - do not adjust regulator higher than marked maximum pressure of attachment.**
- 3. **Risk of injury - do not direct air stream at people or animals.**
- 4. **Do not use to supply breathing air.**
- 5. **Do not leave compressor unattended for an extended period while plugged in.** Unplug compressor after working.

6. **Keep compressor well-ventilated.** Do not cover compressor during use.
7. **Drain Tank daily and after use.** Internal rust causes tank failure and explosion.
8. **Do not remove the valve cover or adjust internal components.**
9. **Compressor head gets hot during operation.** Do not touch it or allow children nearby during or immediately following operation.
10. **Do not use the air hose to move the compressor.**
11. **Release the pressure in the storage tank before moving.**
12. **The use of accessories or attachments not recommended by the manufacturer may result in a risk of injury to persons.**
13. **All air line components, including hoses, pipe, connectors, filters, etc., must be rated for a minimum working pressure of 150 PSI, or 150% of the maximum system pressure, whichever is greater.**
14. **USE OF AN EXTENSION CORD IS NOT RECOMMENDED.** If you choose to use an extension cord, use the following guidelines:
 - a. Make sure your extension cord is in good condition.
 - b. Use an extension cord which is heavy enough to carry the current your product will draw. An undersized cord will cause a drop in line voltage resulting in loss of power and overheating. Table A shows the correct size to use depending on cord length and nameplate ampere rating. If in doubt, use the next heavier gauge. The smaller the gauge number, the heavier the cord.

| RECOMMENDED MINIMUM WIRE GAUGE FOR EXTENSION CORDS (120 VOLT) | | | | |
|---|------------------------------|------------|--------------------|-------------|
| NAMEPLATE AMPERES (at full load) | EXTENSION CORD LENGTH | | | |
| | 25' | 50' | 100' | 150' |
| 0 – 6 | 18 | 16 | 16 | 14 |
| 6.1 – 10 | 18 | 16 | Do not use. | |
| 10.1 – 12 | 16 | 16 | Do not use. | |
| 12.1 – 16 | 14 | 12 | Do not use. | |

TABLE A

15. **Industrial applications must follow OSHA guidelines.**
16. **Maintain labels and nameplates on the compressor.** These carry important safety information. If unreadable or missing, contact Harbor Freight Tools for a replacement.
17. **This product is not a toy.** Keep it out of reach of children.
18. **People with pacemakers should consult their physician(s) before use.** Electromagnetic fields in close proximity to heart pacemaker could cause pacemaker interference or pacemaker failure.
19. **WARNING:** The brass components of this product contain lead, a chemical known to the State of California to cause birth defects (or other reproductive harm). (California Health & Safety code § 25249.5, *et seq.*)
20. **The warnings, precautions, and instructions discussed in this instruction manual cannot cover all possible conditions and situations that may occur.** It must be understood by the operator that common sense and caution are factors which cannot be built into this product, but must be supplied by the operator.



SAVE THESE INSTRUCTIONS.

GROUNDING

WARNING TO PREVENT ELECTRIC SHOCK AND DEATH FROM INCORRECT GROUNDING WIRE CONNECTION:



Check with a qualified electrician if you are in doubt as to whether the outlet is properly grounded. Do not modify the power cord plug provided with the compressor. Never remove the grounding prong from the plug. Do not use the compressor if the power cord or plug is damaged. If damaged, have it repaired by a service facility before use. If the plug will not fit the outlet, have a proper outlet installed by a qualified electrician.

110-120 V~ Grounded Compressors: Compressors with Three Prong Plugs

1. In the event of a malfunction or breakdown, grounding provides a path of least resistance for electric current to reduce the risk of electric shock. This compressor is equipped with an electric cord having an equipment-grounding conductor and a grounding plug. The plug must be plugged into a matching outlet that is properly installed and grounded in accordance with all local codes and ordinances.
2. Do not modify the plug provided – if it will not fit the outlet, have the proper outlet installed by a qualified electrician.

3. Improper connection of the equipment-grounding conductor can result in a risk of electric shock. The conductor with insulation having an outer surface that is green with or without yellow stripes is the equipment-grounding conductor. If repair or replacement of the electric cord or plug is necessary, do not connect the equipment-grounding conductor to a live terminal.
4. Check with a qualified electrician or service personnel if the grounding instructions are not completely understood, or if in doubt as to whether the compressor is properly grounded.
5. Use only 3-wire extension cords that have 3-prong grounding plugs and 3-pole receptacles that accept the compressor's plug.
6. Repair or replace damaged or worn cord immediately.

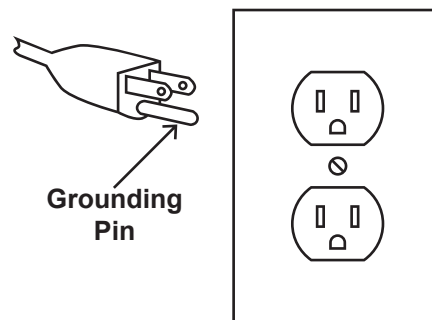







125 V~ 3-Prong Plug and Outlet
(for up to 125 V~ and up to 15 A)

7. This compressor is intended for use on a circuit that has an outlet that looks like the one illustrated above in **125 V~ 3-Prong Plug and Outlet**. The compressor has a grounding plug that looks like the plug illustrated above in **125 V~ 3-Prong Plug and Outlet**.
8. The outlet must be properly installed and grounded in accordance with all codes and ordinances.

9. Do not use an adapter to connect this compressor to a different outlet.

Symbology

| | |
|---|--------------------------------------|
|  | Double Insulated |
|  | Canadian Standards Association |
|  | Underwriters Laboratories, Inc. |
|  | Volts Alternating Current |
|  | Amperes |
|  | No Load Revolutions per Minute (RPM) |

SPECIFICATIONS

| | |
|-------------------------|---|
| Electrical Requirements | 120 V~ / 60 Hz / 2.6 A |
| Air Outlet Size | 1/4" -18 NPT |
| Air Pressure | Auto Shut-Off @ 100 PSI Restart @ 85 PSI |
| Air Tank Capacity | 3 Gallons |
| Air Flow Capacity | 0.6 SCFM @ 90 PSI 1 SCFM @ 40 PSI |
| Pump | Single stage |
| Line Cord | 6' x 18 AWG with 3-prong plug |
| Thermal Protection | Motor equipped with overheat auto shutdown |

NOTE: Allow adequate time when filling tires. The larger the tire, the more time to fill is needed.

NOTE: This product is designed for inflation, stapling, brad nailing and air brushing.

UNPACKING

When unpacking, make sure that the item is intact and undamaged. If any parts are missing or broken, please call Harbor Freight Tools at 1-800-444-3353 as soon as possible.

INSTRUCTIONS FOR PUTTING INTO USE



Read the **ENTIRE IMPORTANT SAFETY INFORMATION** section at the beginning of this manual including all text under subheadings therein before set up or use of this product.

WARNING

TO PREVENT SERIOUS INJURY

FROM ACCIDENTAL OPERATION:

Turn the Switch "OFF", unplug the Compressor from its

electrical outlet, and release all air pressure from the air tank before assembling or making any adjustments to the compressor.

Note: For additional information regarding the parts listed in the following pages, refer to the Assembly Diagram near the end of this manual.

Functions

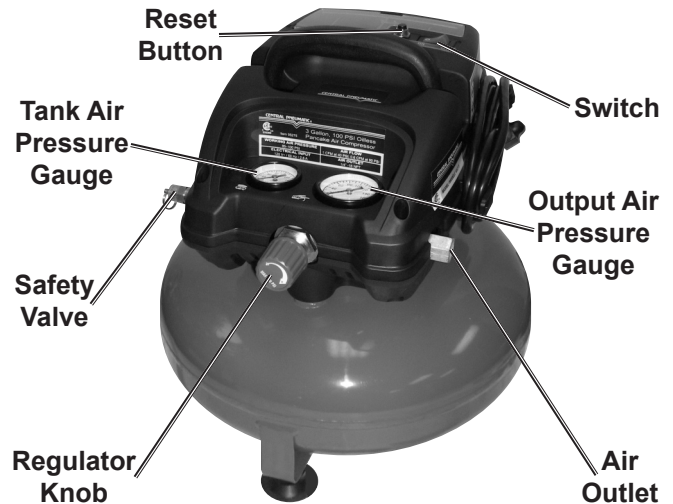

Compressor Area Set Up

1. Designate a work area that is clean and well-lit. The work area must not allow access by children or pets to prevent injury.
2. Locate the Compressor on a flat level surface to prevent tipping and damage. Keep at least 12" of space around the unit to allow air circulation.
3. Route the power cord from the compressor to the grounded wall outlet, along a safe path without creating a tripping hazard or exposing the power cord to possible damage.

Assembly

1. Break in the new Air Compressor as follows:
 - a. Make sure the Switch is OFF and the unit is unplugged. Insert a male coupler (sold separately) into the female Quick Coupler and fully open all regulators and valves.
 - b. Plug in the Power Cord.
 - c. Turn the Switch ON (the | position) and press the Reset button next to the Switch.
 - d. Let the unit run for 30 minutes. Air will expel freely through the Coupler.
 - e. Turn the Switch OFF.
 - f. Unplug the Power Cord and remove the male coupler.

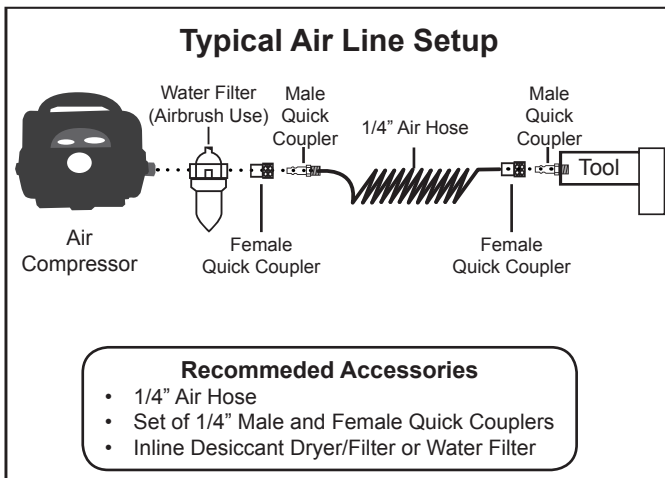

2. Connect a regulator valve, an inline shut off valve and a 1/4" NPT air hose to the Quick Coupler. The air hose must be long enough to reach the work area with enough extra length to allow free movement while working.

Note: An in-line shutoff ball valve is an important safety device because it controls the air supply even if the air hose is ruptured. The shutoff valve should be a ball valve because it can be closed quickly.

3. Depending on the tool which you will be using with this compressor, you may need to incorporate additional components, such as an in-line oiler, a filter, or a dryer (all sold separately). Consult your air tool's manual for needed accessories.

GENERAL OPERATING INSTRUCTIONS



Read the **ENTIRE IMPORTANT SAFETY INFORMATION** section at the beginning of this manual including all text under subheadings therein before set up or use of this product.



1. Turn red regulator knob counterclockwise completely.
2. Close drain valve.
3. Plug the Air Compressor Power Cord into a grounded 120 V electrical outlet.

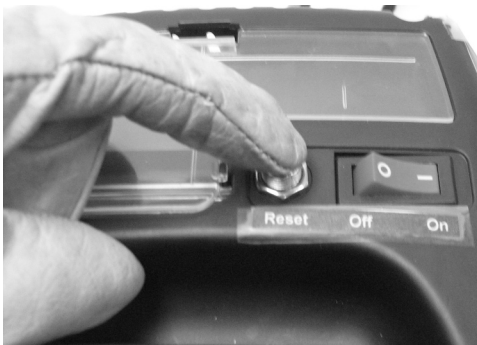

4. Turn the Switch ON (the | position) and press the black Reset button next to the Switch.
5. Allow the Air Compressor to build up pressure. **NOTE: BE SURE TO WAIT UNTIL THE COMPRESSOR SHUTS OFF BEFORE USING (ABOUT 4 MINUTES).**



6. **AFTER** the Compressor builds up enough pressure and shuts off, adjust the Air Compressor's Regulator Knob so that the air output is enough to properly power the tool, but the output will not exceed the tool's maximum air pressure at any time. Turn the knob clockwise to increase the pressure and counter-clockwise to decrease pressure. Adjust the pressure gradually, while checking the air output gauge to set the pressure.

Note: At the beginning of the day's first use of the Air Compressor, check for air leaks by applying soapy water to connections while the Air Compressor is pumping

and after pressure cut-out. Look for air bubbles. If air bubbles are present at connections, tighten connections. Do not use the air compressor unless all connections are air tight, the extra air leaking out will cause the compressor to operate too often, increasing wear on the compressor.

Note: As long as the Switch is ON, the operation of the Air Compressor is automatic, controlled by an internal pressure switch. The Compressor will turn on automatically when the air pressure drops to 85 PSI, and will turn off automatically when the air pressure reaches 100 PSI. **IMPORTANT:** The internal pressure switch is not user adjustable, do not make changes to the air pressure settings of the internal pressure switch. Any change to the automatic pressure levels may cause excess pressure to accumulate, causing a hazardous situation and voiding the warranty.

7. Close the in-line Shutoff Valve between the compressor and the air hose.
8. Make sure the air tool's throttle or switch is in the off position.
9. Connect the air tool to the air hose.
10. Open the in-line Shutoff Valve.

Note: Allow adequate time when filling tires. The larger the tire, the more time to fill is needed.

Note: This product is designed for inflation, stapling, brad nailing and air brushing.

11. Use the air tool as needed.
12. After the job is complete, turn the Switch OFF.
13. Unplug the Air Compressor.

14. Close the in-line Shutoff Valve.
15. Bleed air from the tool then disconnect it.
16. Turn the Drain Valve, at the bottom of the Tank, two turns to release any built-up moisture and the internal tank pressure. Close the valve after moisture has drained out. Do not remove the Drain Valve.
17. Clean, then store the Air Compressor indoors.

Emergency Depressurization

If it is necessary to quickly *depressurize* the Compressor, turn the Switch OFF. Then, pull on the ring on the Safety Valve to quickly release stored air pressure.

Automatic Shut off System

1. If the Compressor automatically shuts off:
 - a. Shut off all tools.
 - b. Wait until the Compressor cools down (about 10 minutes);
 - c. Press the Reset Button to start the compressor;
 - d. Resume operation.
2. Possible causes of repeated automatic shut off of the compressor are:
 - a. Using an extension cord that is too long or narrow;
 - b. An air leak or open hose causing the compressor to cycle too often and build up heat.
3. Correct any issues before further use to avoid damage to the compressor.

MAINTENANCE AND SERVICING



Procedures not specifically explained in this manual must be performed only by a qualified technician.

WARNING

TO PREVENT SERIOUS INJURY

FROM ACCIDENTAL OPERATION:

Turn the Switch “OFF”, unplug the Compressor from its electrical outlet, and release all air pressure from the air tank before performing any inspection, maintenance, or cleaning procedures.

TO PREVENT SERIOUS INJURY FROM COMPRESSOR FAILURE:

Do not use damaged equipment. If abnormal noise or vibration occurs, have the problem corrected before further use.

Cleaning, Maintenance, and Lubrication

1. **BEFORE EACH USE**, inspect the general condition of the Air Compressor. Check for loose hardware, misalignment or binding of moving parts, cracked or broken parts, damaged electrical wiring, and any other condition that may affect its safe operation.
2. **AFTER USE**, wipe external surfaces of the compressor with a clean cloth.
3. **WARNING!** If the supply cord of this compressor is damaged, it must be replaced only by a qualified service technician.

Maintenance Schedule

Following are general guidelines for maintenance checks of the Air Compressor.

Note: The environment in which the compressor is used, and the frequency of use can affect how often you will need to check the Air Compressor components and perform maintenance procedures.

Daily:

- a. Make sure all nuts and bolts are tight.
- b. Drain moisture from air tank.
- c. Check for abnormal noise or vibration.
- d. Check for air leaks.*
- e. Wipe off any oil or dirt from the compressor.**

Monthly:

- a. Inspect Safety Valve.

Draining Moisture from the Tank

The Drain Valve is located under the Tank. It must be accessed daily to release all trapped air and moisture from the Tank. This will eliminate condensation which can cause internal tank corrosion.

To empty the air and condensation:

1. Switch the compressor off.
2. Place a collection pan under the Drain Valve.
3. Unthread the Drain Valve two or three turns ONLY.
4. When all the pressure and moisture is released, close the Drain Valve.

* To check for air leaks, apply soapy water to joints while the Air Compressor is pressurized. Look for air bubbles.

** To clean the compressor surface, wipe with a damp cloth, using a mild detergent or mild solvent.

Troubleshooting

| Problem | Possible Causes | Likely Solutions |
|---|---|---|
| Compressor does not start or restart | <ol style="list-style-type: none"> 1. No power at outlet. 2. Power cord not plugged in properly. 3. Thermal overload switch tripped. 4. Building power supply circuit tripped or blown fuse. 5. Tank is already pressurized. 6. Cord wire size is too small or cord is too long to properly power compressor. 7. Compressor needs service. | <ol style="list-style-type: none"> 1. Reset circuit breaker, or have outlet serviced by a qualified technician. 2. Check that cord is plugged in securely. 3. Turn off Tool. Turn off Compressor and wait for it to cool down. Press reset button. Resume operation. 4. Reset circuit or replace fuse. Check for low voltage conditions. It may be necessary to disconnect other electrical appliances from the circuit or move the compressor to its own circuit. 5. No problem. Compressor will start when needed. 6. Use larger diameter or shorter extension cord or eliminate extension cord. See Recommended Wire Gauge for Extension Cords in Safety section. 7. Have unit inspected by a qualified technician. |
| Compressor not building enough air pressure | <ol style="list-style-type: none"> 1. Compressor not large enough for job. 2. Loose fittings. 3. Hose or hose connections not adequate. 4. High altitude reducing air output. 5. Check Valve needs service. | <ol style="list-style-type: none"> 1. Check if accessory SCFM is met by Compressor. If Compressor cannot supply enough air flow (SCFM), you need a larger Compressor. 2. Reduce air pressure, then check all fittings with a soap solution for air leaks and tighten as needed. Do not overtighten. 3. Replace with larger hose and/or hose connections. 4. You may need a larger compressor if you are situated in a high altitude location. 5. Clean or replace, as needed. |
| Overheating | <ol style="list-style-type: none"> 1. Unusually dusty environment. 2. Cord is too small of a gauge or too long to handle compressor. 3. Unit not on level surface. | <ol style="list-style-type: none"> 1. Move unit to cleaner environment. 2. Increase cord size or use shorter length extension cord, or eliminate extension cord. See Recommended Wire Gauge for Extension Cords in Safety section. 3. Reposition unit on a level surface. |
| <div style="display: flex; align-items: center;">  <p>Follow all safety precautions whenever diagnosing or servicing the compressor. Disconnect power supply before service.</p> </div> | | |

| Problem | Possible Causes | Likely Solutions |
|---|---|---|
| Compressor starts and stops excessively | <ol style="list-style-type: none"> 1. Compressor not large enough for job. 2. Loose fittings. | <ol style="list-style-type: none"> 1. Check if accessory SCFM is met by Compressor. If Compressor doesn't reach accessory SCFM, you need a larger Compressor. 2. Reduce air pressure, then check all fittings with a soap solution for air leaks and tighten as needed. Do not overtighten. |
| Moisture in discharge air | Too much moisture in air. | Install inline air filter/dryer, and/or relocate to less humid environment. |
| Safety Valve "pops" | Safety valve needs service. | Pull on test ring of safety valve. If it still pops, replace. |
| Air leaking from fittings | Loose fittings. | Reduce air pressure, then check all fittings with a soap solution for air leaks and tighten as needed. Do not overtighten. |
| Air leaks from tank | Defective or rusted tank. | Have tank replaced by a qualified technician. |
|  Follow all safety precautions whenever diagnosing or servicing the compressor. Disconnect power supply before service. | | |

PARTS LIST

| Part | Description | Q'ty | Part | Description | Q'ty |
|------|-------------------------|------|------|---|------|
| 1 | Tank, 3G | 1 | 31 | O-ring, D31.5x1.8 | 1 |
| 2 | Cover, Upper | 1 | 32 | Circuit Board | 1 |
| 3 | Cover, Bottom | 1 | 33 | Muffler | 1 |
| 4 | Tube, Copper | 1 | 34 | Fan | 1 |
| 5 | Switch | 1 | 35 | Screw, M5x10 | 1 |
| 6 | Safety Valve | 1 | 36 | Screw, M4x8 | 2 |
| 7 | Handle | 1 | 37 | Screw, M3x6 | 4 |
| 8 | Foot | 3 | 38 | Screw, M6x10 | 1 |
| 9 | Gauge, Pressure, Output | 1 | 39 | Washer, D6 | 11 |
| 10 | Damping Pad | 4 | 40 | Screw, M4x40 | 4 |
| 11 | Drain Valve Assembly | 1 | 41 | Power Cord | 1 |
| 12 | Tube, Connecting | 1 | 42 | Cord Holder | 1 |
| 13 | Nut | 1 | 43 | Gauge, Pressure, Tank | 1 |
| 14 | Pressure Switch | 1 | 44 | Screw, M6x25 | 4 |
| 15 | Connector | 2 | 45 | Washer, Lock | 1 |
| 16 | Nut | 2 | 46 | Screw, M6x15 | 6 |
| 17 | Regulator | 1 | 47 | Screw, ST4.8x15 | 1 |
| 18 | Motor Assembly | 1 | 48 | Screw, M5x25 | 2 |
| 19 | Bearing, 608-2Z | 3 | 49 | Washer, D5 | 2 |
| 20 | Crank | 1 | 50 | Reset Button (4A Overload Protector) | 1 |
| 21 | Piston | 1 | 51 | Nut, Overload Protector | 1 |
| 22 | Air Input Valve | 1 | 52 | Wire, Electric | 1 |
| 23 | Plane Keeper, Copper | 2 | 53 | Terminal Sheath | 2 |
| 24 | O-ring, D21.2x2.5 | 1 | 54 | Terminal | 2 |
| 25 | Piston Ring | 1 | 55 | Spring | 1 |
| 26 | Cylinder | 1 | 56 | Ball | 1 |
| 27 | Cover, Outlet Valve | 1 | 57 | O-ring, D14x1.8 | 1 |
| 28 | Outlet Valve | 1 | 58 | Screw, ST4.2x25 | 4 |
| 29 | O-ring, D31x2 | 1 | | | |
| 30 | Cover, Cylinder | 1 | | | |

PLEASE READ THE FOLLOWING CAREFULLY

THE MANUFACTURER AND/OR DISTRIBUTOR HAS PROVIDED THE PARTS LIST AND ASSEMBLY DIAGRAM IN THIS MANUAL AS A REFERENCE TOOL ONLY. NEITHER THE MANUFACTURER OR DISTRIBUTOR MAKES ANY REPRESENTATION OR WARRANTY OF ANY KIND TO THE BUYER THAT HE OR SHE IS QUALIFIED TO MAKE ANY REPAIRS TO THE PRODUCT, OR THAT HE OR SHE IS QUALIFIED TO REPLACE ANY PARTS OF THE PRODUCT. IN FACT, THE MANUFACTURER AND/OR DISTRIBUTOR EXPRESSLY STATES THAT ALL REPAIRS AND PARTS REPLACEMENTS SHOULD BE UNDERTAKEN BY CERTIFIED AND LICENSED TECHNICIANS, AND NOT BY THE BUYER. THE BUYER ASSUMES ALL RISK AND LIABILITY ARISING OUT OF HIS OR HER REPAIRS TO THE ORIGINAL PRODUCT OR REPLACEMENT PARTS THERETO, OR ARISING OUT OF HIS OR HER INSTALLATION OF REPLACEMENT PARTS THERETO.

ASSEMBLY DIAGRAM

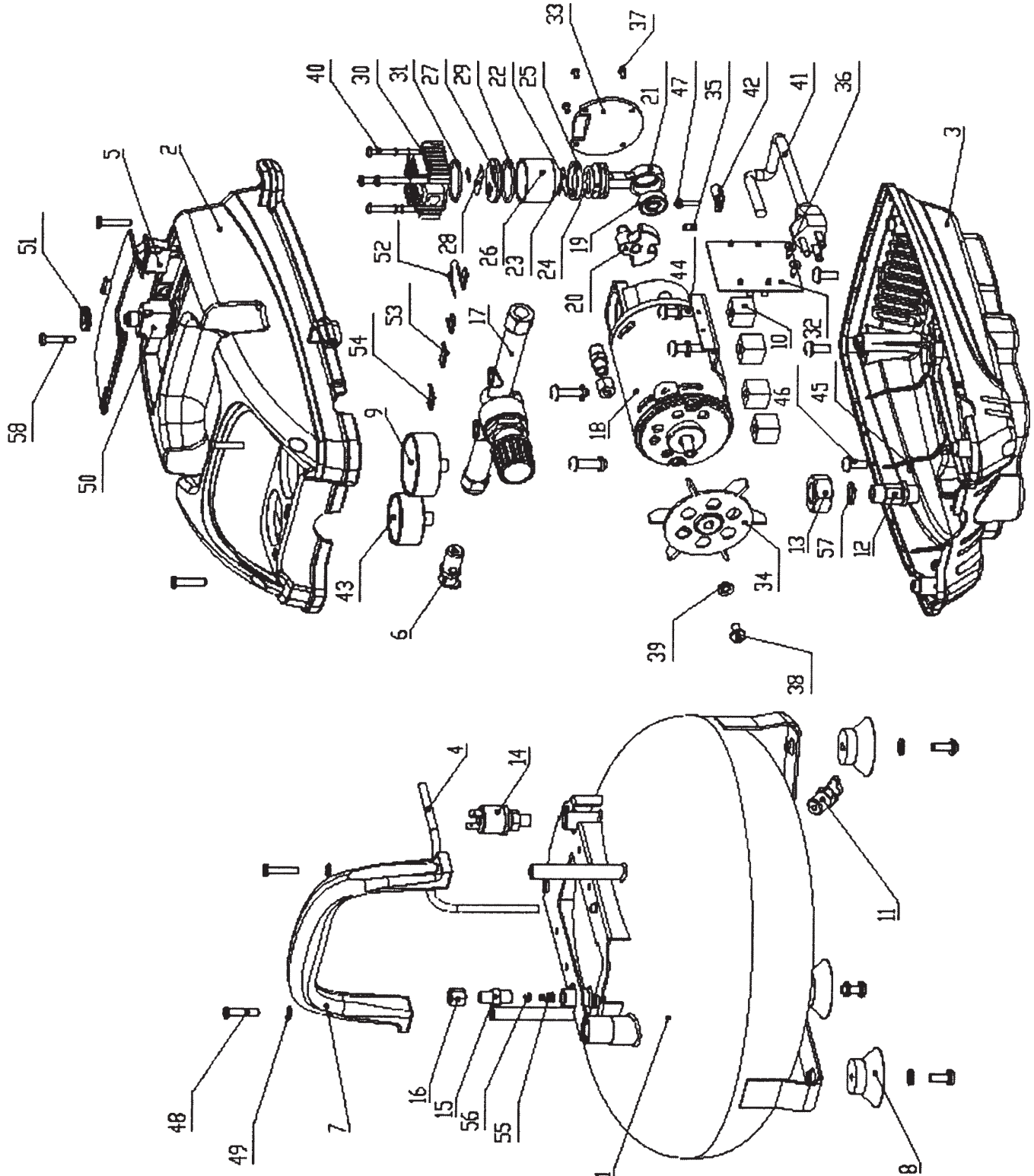

Record Product's Serial Number Here: _____

Note: If product has no serial number, record month and year of purchase instead.

Note: Some parts are listed and shown for illustration purposes only, and are not available individually as replacement parts.

LIMITED 1 YEAR / 90 DAY WARRANTY

Harbor Freight Tools Co. makes every effort to assure that its products meet high quality and durability standards, and warrants to the original purchaser that for a period of one year from date of purchase that the tank is free of defects in materials and workmanship (90 days if used by a professional contractor or if used as rental equipment). Harbor Freight Tools also warrants to the original purchaser, for a period of ninety days from date of purchase, that all other parts and components of the product are free from defects in materials and workmanship. This warranty does not apply to damage due directly or indirectly to misuse, abuse, negligence or accidents, repairs or alterations outside our facilities, normal wear and tear, or to lack of maintenance. We shall in no event be liable for death, injuries to persons or property, or for incidental, contingent, special or consequential damages arising from the use of our product. Some states do not allow the exclusion or limitation of incidental or consequential damages, so the above limitation of exclusion may not apply to you. THIS WARRANTY IS EXPRESSLY IN LIEU OF ALL OTHER WARRANTIES, EXPRESS OR IMPLIED, INCLUDING THE WARRANTIES OF MERCHANTABILITY AND FITNESS.

To take advantage of this warranty, the product or part must be returned to us with transportation charges prepaid. Proof of purchase date and an explanation of the complaint must accompany the merchandise. If our inspection verifies the defect, we will either repair or replace the product at our election or we may elect to refund the purchase price if we cannot readily and quickly provide you with a replacement. We will return repaired products at our expense, but if we determine there is no defect, or that the defect resulted from causes not within the scope of our warranty, then you must bear the cost of returning the product.

This warranty gives you specific legal rights and you may also have other rights which vary from state to state.

3491 Mission Oaks Blvd. • PO Box 6009 • Camarillo, CA 93011 • (800) 444-3353