

CENTRALPNEUMATIC®

17 GALLON OILLESS AIR COMPRESSOR

Model 68066

26 GALLON OILLESS AIR COMPRESSOR

Model 68067

SET UP AND OPERATING INSTRUCTIONS



Visit our website at: <http://www.harborfreight.com>



**Read this material before using this product.
Failure to do so can result in serious injury.
SAVE THIS MANUAL.**

For technical questions or replacement parts, please call 1-800-444-3353.



IMPORTANT



DO NOT RETURN TO STORE

This unit was fully tested and inspected prior to shipment and will operate properly when instructions are followed. Refer to your owner's manual for basic troubleshooting. **To avoid unnecessary return to the store, simply call Compressor Support toll free for additional assistance.**



Compressor Support: 1-800-444-3353

Please have your model number and serial number available. These can be found on the data label on your product. Retain a copy of your receipt with purchase date for reference.

NOTICE

- Air Compressor will automatically shut off when maximum PSI is reached. When the tank pressure drops to the cut in pressure (low pressure) and the on/off switch is in the ON position, the unit will automatically restart.
- On occasion, maximum pressure in tank will remain until next use thus resulting in a sense of no power (See bullet above).
- To avoid power loss, overheating and ensure power, use additional air hose rather than extension cords.
- It is the consumer's responsibility to drain oil lubed units prior to shipment to meet ICC, state and local fire regulations.

TABLE OF CONTENTS

- Introduction 2
- General Safety Rules 3-4
- Specific Safety Rules 5
- Symbols..... 6-7
- Electrical..... 8
- Glossary of Terms 9
- Tools Needed 9
- Features 10-11
- Assembly..... 11-13
- Operation..... 14-15
- Maintenance..... 16
- Troubleshooting..... 17
- Warranty 20

INTRODUCTION

This tool has many features for making its use more pleasant and enjoyable. Safety, performance, and dependability have been given top priority in the design of this product making it easy to maintain and operate.



DANGER

This compressor/pump is not equipped and should not be used to supply breathing quality air. Additional equipment would be necessary to properly filter and purify the air to meet minimal specifications for Grade D breathing as described in Compressed Gas Association Commodity Specification G 7.1 - 1966, OSHA 29 CFR 1910.134. Compressed Gas Association, 4221 Walney Road, Fifth Floor, Chantilly, VA 20151-2923, (703) 788-2700, www.cganet.com. Any such additional equipment has not been examined and no implication of proper use for breathing air is intended or implied.

If this compressor is altered in any way, existing warranties shall be voided. Harbor Freight Tools disclaims any liabilities whatsoever for any loss, personal injury, or damage.

GENERAL SAFETY RULES



WARNING:

Read and understand all instructions. Failure to follow all instructions listed below may result in electric shock, fire, and/or serious personal injury.

SAVE THESE INSTRUCTIONS

WORK AREA

- **Keep your work area clean and well lit.** Cluttered benches and dark areas invite accidents. Floor must not be slippery from wax or dust.
- **Do not operate power tools in explosive atmospheres, such as in the presence of flammable liquids, gases, or dust.** Power tools create sparks which may ignite the dust or fumes.
- **Keep bystanders, children, and visitors away while operating tools.** Distractions can cause you to lose control.
- **Operate air compressor in an open area at least 18 in. away from any wall or object that could restrict the flow of fresh air to ventilation openings.**

ELECTRICAL SAFETY

- **Avoid body contact with grounded surfaces such as pipes, radiators, ranges, and refrigerators.** There is an increased risk of electric shock if your body is grounded.
- **Don't expose power tools to rain or wet conditions.** Water entering a power tool will increase the risk of electric shock.
- **Do not abuse the cord. Never use the cord to carry the tool or pull the plug from an outlet. Keep cord away from heat, oil, sharp edges, or moving parts. Replace damaged cords immediately.** Damaged cords increase the risk of electric shock.
- **When operating a power tool outside, use an outdoor extension cord marked "W-A" or "W".** These cords are rated for outdoor use and reduce the risk of electric shock.

PERSONAL SAFETY

- **Eye protection which conforms to ANSI specifications and provides protection against flying particles both from the FRONT and SIDE should ALWAYS be worn by the operator and others in the work area when loading, operating, or servicing this tool.** Eye protection is required to guard against flying fasteners and debris, which could cause severe eye injury.
- **The employer and/or user must ensure that proper eye protection is worn.** We recommend a Wide Vision Safety Mask for use over eyeglasses or standard safety glasses that provide protection against flying particles both from the front and side. Always use eye protection which is marked to comply with ANSI Z87.1.

- **Additional safety protection will be required in some environments.** For example, the working area may include exposure to a noise level which can lead to hearing damage. The employer and user must ensure that any necessary hearing protection is provided and used by the operator and others in the work area. Some environments will require the use of head protection equipment. When required, the employer and user must ensure that head protection marked to comply with ANSI Z89.1 is used.
- **Stay alert, watch what you are doing, and use common sense when operating a power tool. Do not use tool while tired or under the influence of drugs, alcohol, or medication.** A moment of inattention while operating power tools may result in serious personal injury.
- **Dress properly. Do not wear loose clothing or jewelry. Contain long hair. Keep your hair, clothing, and gloves away from moving parts.** Loose clothes, jewelry, or long hair can be caught in moving parts.
- **Do not overreach. Keep proper footing and balance at all times.** Proper footing and balance enables better control of the tool in unexpected situations.
- **Use safety equipment. Always wear eye protection.** Dust mask, nonskid safety shoes, hard hat, or hearing protection must be used for appropriate conditions.
- **Do not use on a ladder or unstable support.** Stable footing on a solid surface enables better control of the tool in unexpected situations.

TOOL USE AND CARE

- **Do not exceed the pressure rating of any component in the system.**
- **Protect material lines and air lines from damage or puncture.** Keep hose and power cord away from sharp objects, chemical spills, oil, solvents, and wet floors.
- **Check hoses for weak or worn condition before each use, making certain all connections are secure.** Do not use if defect is found. Purchase a new hose or notify an authorized service center for examination or repair.
- **Release all pressures within the system slowly.** Dust and debris may be harmful.
- **Store idle tools out of the reach of children and other untrained persons.** Tools are dangerous in the hands of untrained users.
- **Maintain tools with care.** Follow maintenance instructions. Properly maintained tools are easier to control.
- **Check for misalignment or binding of moving parts, breakage of parts, and any other condition that may affect the tool's operation. If damaged, have the tool serviced before using.** Many accidents are caused by poorly maintained tools.

GENERAL SAFETY RULES

- **Never point any tool toward yourself or others.**
- **Keep the exterior of the air compressor dry, clean, and free from oil and grease.** Always use a clean cloth when cleaning. Never use brake fluids, gasoline, petroleum-based products, or any strong solvents to clean the unit. Following this rule will reduce the risk of deterioration of the enclosure plastic.

SERVICE











- **Tool service must be performed only by qualified repair personnel.** Service or maintenance performed by unqualified personnel may result in a risk of injury.
- **Disconnect power supply, open drain valve to decompress tank and allow water to drain, and allow air compressor to become cool to the touch before servicing.** Turn pressure regulator knob fully counter clockwise after shutting off compressor.
- **When servicing a tool, use only identical replacement parts. Follow instructions in the Maintenance section of this manual.** Use of unauthorized parts or failure to follow Maintenance instructions may create a risk of injury.

SPECIFIC SAFETY RULES

- **Know your power tool.** Read operator's manual carefully. Learn its applications and limitations, as well as the specific potential hazards related to this tool. Following this rule will reduce the risk of electric shock, fire, or serious injury.
- **Drain tank of moisture after each day's use.** If unit will not be used for a while, it is best to leave drain valve open until such time as it is to be used. This will allow moisture to completely drain out and help prevent corrosion on the inside of tank.
- **Risk of Fire or Explosion.** Do not spray flammable liquid in a confined area. Spray area must be well ventilated. Do not smoke while spraying or spray where spark or flame is present. Keep compressors as far from the spraying area as possible, at least 15 feet from the spraying area and all explosive vapors.
- **Risk of Bursting.** Do not adjust regulator to result in output pressure greater than marked maximum pressure of attachment. Do not use at pressure greater than the rated maximum pressure of this compressor.
- **If connected to a circuit protected by fuses,** use time-delay fuses with this product.
- **To reduce the risk of electric shock,** do not expose to rain. Store indoors.
- **Inspect tank yearly for rust, pin holes, or other imperfections that could cause it to become unsafe.** Never weld or drill holes in the air tank.
- **Make sure the hose is free of obstructions or snags.** Entangled or snarled hoses can cause loss of balance or footing and may become damaged.
- **Use the air compressor only for its intended use. Do not alter or modify the unit from the original design or function.**
- **Always be aware that misuse and improper handling of this tool can cause injury to yourself and others.**
- **Never leave a tool unattended with the air hose attached.**
- **Do not operate this tool if it does not contain a legible warning label.**
- **Do not continue to use a tool or hose that leaks air or does not function properly.**
- **Always disconnect the air supply and power supply before making adjustments, servicing a tool, or when a tool is not in use.**
- **Do not attempt to pull or carry the air compressor by the hose.**
- **Your tool may require more air consumption than this air compressor is capable of providing.**
- **Always follow all safety rules recommended by the manufacturer of your air tool, in addition to all safety rules for the air compressor.** Following this rule will reduce the risk of serious personal injury.
- **Never direct a jet of compressed air toward people or animals. Take care not to blow dust and dirt towards yourself or others.** Following this rule will reduce the risk of serious injury.
- **Protect your lungs.** Wear a face or dust mask if the operation is dusty. Following this rule will reduce the risk of serious personal injury.
- **Do not use this air compressor to spray chemicals.** Your lungs can be damaged by inhaling toxic fumes. A respirator may be necessary in dusty environments or when spraying paint. Do not carry while painting.
- **Inspect tool cords and hoses periodically and, if damaged, have repaired at your nearest Authorized Service Center. Constantly stay aware of cord location.** Following this rule will reduce the risk of electric shock or fire.
- **Never use an electrical adaptor with this grounded plug.**
- **Check damaged parts. Before further use of the air compressor or air tool, a guard or other part that is damaged should be carefully checked to determine that it will operate properly and perform its intended function. Check for alignment of moving parts, binding of moving parts, breakage of parts, mounting, and any other conditions that may affect its operation. A guard or other part that is damaged should be properly repaired or replaced by an authorized service center.** Following this rule will reduce the risk of shock, fire, or serious injury.
- **Make sure your extension cord is in good condition. When using an extension cord, be sure to use one heavy enough to carry the current your product will draw. A wire gauge size (A.W.G.) of at least 14 is recommended for an extension cord 50 feet or less in length. A cord exceeding 100 feet is not recommended. If in doubt, use the next heavier gauge. The smaller the gauge number, the heavier the cord.** An undersized cord will cause a drop in line voltage resulting in loss of power and overheating.
- **Save these instructions.** Refer to them frequently and use them to instruct others who may use this air compressor. If you loan someone this tool, loan them these instructions also.



SYMBOLS

Some of the following symbols may be used on this tool. Please study them and learn their meaning. Proper interpretation of these symbols will allow you to operate the tool better and safer.

SYMBOL	NAME	DESIGNATION/EXPLANATION
V	Volts	Voltage
A	Amperes	Current
Hz	Hertz	Frequency (cycles per second)
~	Alternating Current	Type of current
	Class II Construction	Double-insulated construction
	Wet Conditions Alert	Do not expose to rain or use in damp locations.
	Read The Operator's Manual	To reduce the risk of injury, user must read and understand operator's manual before using this product.
	Eye Protection	Always wear safety goggles, safety glasses with side shields, or a full face shield when operating this product.
	Safety Alert	Precautions that involve your safety.
	Risk of Bursting	Do not adjust regulator to result in output pressure greater than marked maximum pressure of attachment. Do not use at pressure greater than the rated maximum pressure of this compressor.
	Risk of Fire or Explosion	Do not spray flammable liquid in a confined area. Spray area must be well ventilated. Do not smoke while spraying or spray where spark or flame is present. Keep compressors as far from the spraying area as possible, at least 15 feet from the spraying area and all explosive vapors.
	Risk of Electrical Shock	Hazardous Voltage: Disconnect from power source before servicing. Compressor must be grounded.
	Hot Surface	To reduce the risk of injury or damage, avoid contact with any hot surface.
	Risk to hearing	Always wear ear protection when using this tool. Failure to do so may result in hearing loss.
	Risk to Breathing	Air obtained directly from the air compressor should never be used to supply air for human consumption.

SYMBOLS

The following signal words and meanings are intended to explain the levels of risk associated with this product.

SYMBOL	SIGNAL	MEANING
	DANGER:	Indicates an imminently hazardous situation, which, if not avoided, will result in death or serious injury.
	WARNING:	Indicates a potentially hazardous situation, which, if not avoided, could result in death or serious injury.
	CAUTION:	Indicates a potentially hazardous situation, which, if not avoided, may result in minor or moderate injury.
	CAUTION:	(Without Safety Alert Symbol) Indicates a situation that may result in property damage.

SERVICE

Servicing requires extreme care and knowledge and should be performed only by a qualified service technician. For service we suggest you return the product to the nearest **AUTHORIZED SERVICE CENTER** for repair. When servicing, use only identical replacement parts.



WARNING:

To avoid serious personal injury, do not attempt to use this product until you read thoroughly and understand completely the operator's manual. Save this operator's manual and review frequently for continuing safe operation and instructing others who may use this product.



WARNING:



The operation of any power tool can result in foreign objects being thrown into your eyes, which can result in severe eye damage. Before beginning power tool operation, always wear safety goggles, safety glasses with side shields, or a full face shield when needed. We recommend Wide Vision Safety Mask for use over eyeglasses or standard safety glasses with side shields. Always use eye protection which is marked to comply with ANSI Z87.1.

SAVE THESE INSTRUCTIONS

ELECTRICAL

EXTENSION CORDS

Use only 3-wire extension cords that have 3-prong grounding plugs and 3-pole receptacles that accept the air compressor's plug. When using the air compressor at a considerable distance from the power source, use an extension cord heavy enough to carry the current that the compressor will draw. An undersized extension cord will cause a drop in line voltage, resulting in a loss of power and causing the motor to overheat. Use the chart provided below to determine the minimum wire size required in an extension cord. Only round jacketed cords listed by Underwriter's Laboratories (UL) should be used.

**Ampere rating (on air compressor data plate)

Cord Length	Wire Size (A.W.G.)					
	0-2.0	2.1-3.4	3.5-5.0	5.1-7.0	7.1-12.0	12.1-16.0
25'	16	16	16	16	14	14
50'	16	16	16	14	14	12
100'	16	16	14	12	10	—

**Used on 12 gauge - 20 amp circuit.

NOTE: AWG = American Wire Gauge

When working with the air compressor outdoors, use an extension cord that is designed for outside use. This is indicated by the letters "WA" on the cord's jacket.

Before using an extension cord, inspect it for loose or exposed wires and cut or worn insulation.

⚠ WARNING:

Keep the extension cord clear of the working area. Position the cord so that it will not get caught on lumber, tools, or other obstructions while you are working with a power tool. Failure to do so can result in serious personal injury.

⚠ WARNING:

Check extension cords before each use. If damaged, replace immediately. Never use air compressor with a damaged cord since touching the damaged area could cause electrical shock resulting in serious injury.

NOTE: Use longer air hoses instead of long extension cords. Your air compressor will run better and last longer.

ELECTRICAL CONNECTION

This air compressor is powered by a precision built electric motor. It should be connected to a **power supply that is 120 volts, 60 Hz, AC only (normal household current)**. Do not operate this tool on direct current (DC). A substantial voltage drop will cause a loss of power and the motor will overheat. If the air compressor does not operate when plugged into an outlet, double check the power supply.

SPEED AND WIRING

The no-load speed of the electric motor varies by model and specification. The motor speed is not constant and decreases under a load or with lower voltage. For voltage, the wiring in a shop is as important as the motor's horsepower rating. A line intended only for lights cannot properly carry a power tool motor. Wire that is heavy enough for a short distance will be too light for a greater distance. A line that can support one power tool may not be able to support two or three tools.

GROUNDING INSTRUCTIONS

This product must be grounded. In the event of an electrical short circuit, grounding reduces the risk of electric shock by providing an escape wire for the electric current. This air compressor is equipped with an electric cord having an equipment-grounding conductor and a grounding plug. The plug must be plugged into a matching outlet that is properly installed and grounded in accordance with all local codes and ordinances.

Do not modify the plug provided. If it will not fit the outlet, have the proper outlet installed by a qualified electrician.

⚠ WARNING:

Improper connection of the equipment-grounding conductor can result in a risk of electric shock.

The conductor with insulation having an outer surface that is green with or without yellow stripes is the equipment-grounding conductor. If repair or replacement of the electric cord or plug is necessary, do not connect the equipment-grounding conductor to a live terminal.

Check with a qualified electrician or service personnel if the grounding instructions are not completely understood, or if in doubt as to whether the tool is properly grounded.

Repair or replace a damaged or worn cord immediately.

This product is for use on a nominal 120-V circuit and has a grounding plug similar to the plug illustrated in Figure 1. Only connect the product to an outlet having the same configuration as the plug. Do not use an adapter with this product.

Never use an electrical adaptor with this grounded plug.

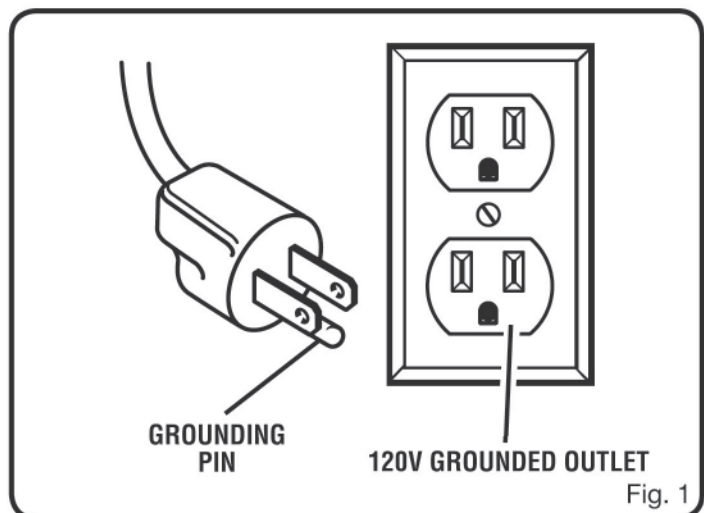

GLOSSARY OF TERMS

Air Filter

Porous element contained within a metal or plastic housing attached to the compressor cylinder head which removes impurity from the intake air of the compressor.

Air Tank

Cylindrical component which contains the compressed air.

Check Valve

Device that prevents compressed air from flowing back from the air tank to the compressor pump.

Cut-In Pressure

The low pressure at which the motor will automatically restart.

Cut-Off Pressure

The high pressure at which the motor will automatically shut off.

Electric Motor

Device which provides the rotational force necessary to operate the compressor pump.

Manual On/Off Switch

Control which turns the air compressor on or off. The pressure switch will not automatically start and control the compressor unless the manual On/Off Switch is in the **ON (I)** position.

NPT (National Pipe Thread)

National Pipe Thread is a U.S. standard for tapered (NPT) or straight (NPS) threads used to join pipes and fittings. A thread sealing tape must be used to provide a leak-free seal on pipe threaded connections.

Pressure Regulator Knob

Regulates the outgoing pressure from the air outlet to the tool. It is possible to increase or decrease the pressure at the outlet by adjusting this control knob.

Pressure Switch

Automatically controls the on/off cycling of the compressor. It stops the compressor when the cut-off pressure in the tank is reached and starts the compressor when the air pressure drops below the cut-in pressure.

PSI (Pounds Per Square Inch)

Measurement of the pressure exerted by the force of the air. The actual psi is measured by a pressure gauge on the compressor.

Pump

Produces the compressed air with a reciprocating piston contained within the cylinder.

Regulator Pressure Gauge

Displays the current line pressure. Line pressure is adjusted by rotating the pressure regulator knob.

Safety Valve

Prevents air pressure in the air tank from rising over a predetermined limit.

SCFM (Standard Cubic Feet Per Minute)

A unit of measure of air delivery.

Tank Pressure Gauge

Indicates the pressure in the air tank.

Thermal Overload Switch

Automatically shuts off the compressor if the temperature of the electric motor exceeds a predetermined limit.

TOOLS NEEDED

The following tools are needed in order to assemble the wheel kit.



TWO ADJUSTABLE WRENCHES

FEATURES

PRODUCT SPECIFICATIONS

Model 68066

Running Horsepower.....	1.8 HP
Air Tank Capacity.....	17 gal.
Air Pressure.....	150 PSI max.
Air Delivery.....	6.0 SCFM @ 40 PSI
	4.0 SCFM @ 90 PSI
Lubrication.....	Oil-Free
Gauges.....	1.5 in. diameter
Input.....	120 V, 60 Hz, AC only, 13.5 Amps
Net Weight.....	70.1 lbs.

Model 68067

Running Horsepower.....	1.8 HP
Air Tank Capacity.....	26 gal.
Air Pressure.....	150 PSI max.
Air Delivery.....	6.0 SCFM @ 40 PSI
	4.0 SCFM @ 90 PSI
Lubrication.....	Oil-Free
Gauges.....	1.5 in. diameter
Input.....	120 V, 60 Hz, AC only, 13.5 Amps
Net Weight.....	93 lbs.

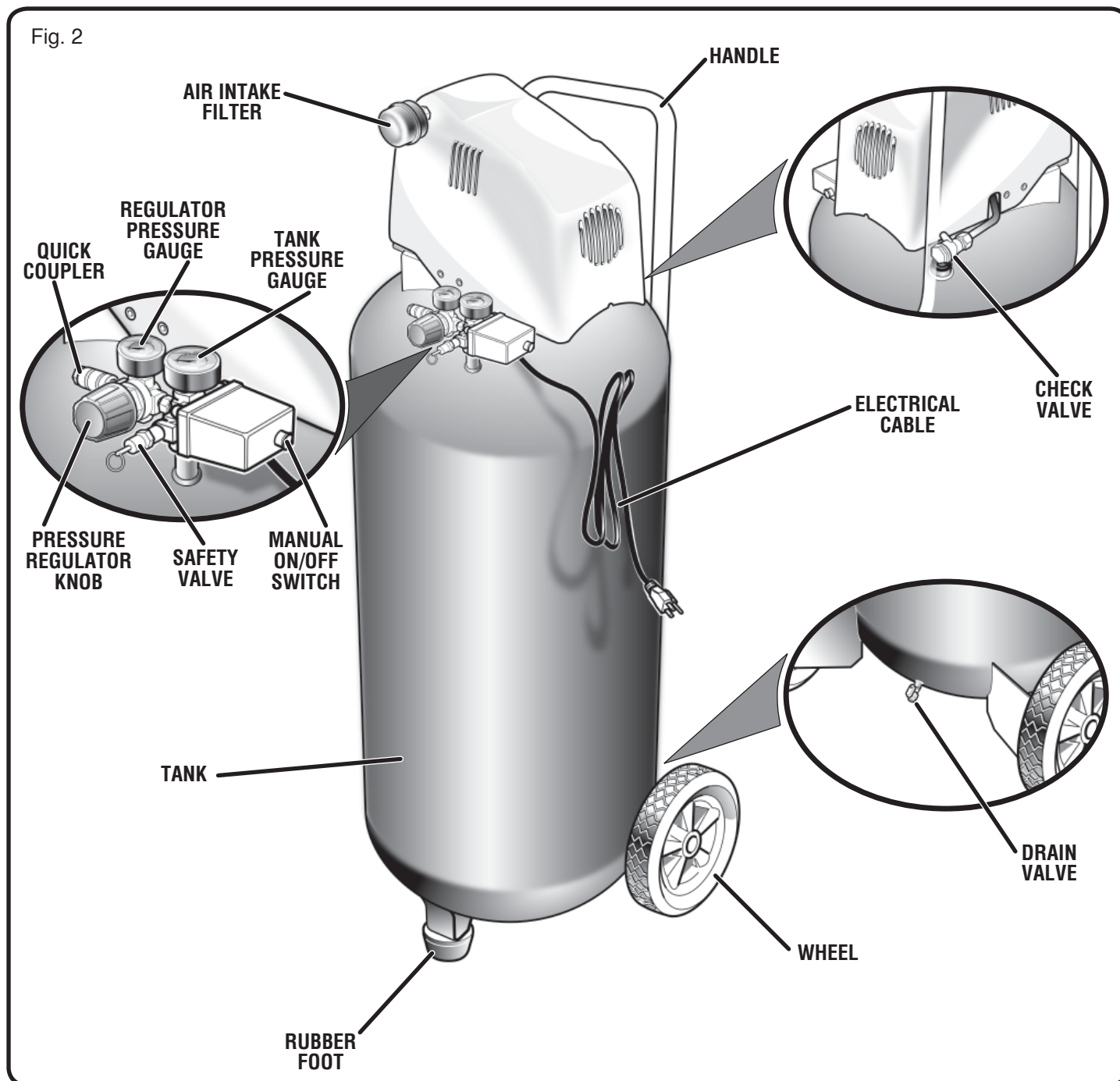

FEATURES

KNOW YOUR AIR COMPRESSOR

See Figure 2.

Before attempting to use this product, familiarize yourself with all operating features and safety rules.

OIL-FREE UNIVERSAL MOTOR

Your air compressor features permanently lubricated bearings.

PRESSURE REGULATOR KNOB

Use the pressure regulator knob to adjust the amount of air being delivered through the hose.

REGULATOR PRESSURE GAUGE

The current line pressure is displayed on the regulator pressure gauge. This pressure can be adjusted by rotating the pressure regulator knob.

SAFETY VALVE

The safety valve is designed to automatically release air if the air receiver pressure exceeds the preset maximum.

TANK PRESSURE GAUGE

The tank pressure gauge indicates the pressure of the air in the tank.

ASSEMBLY

UNPACKING

This product has been shipped completely assembled.

- Carefully remove the compressor from the box. Make sure that all items listed in the packing list are included.
- Inspect the compressor carefully to make sure no breakage or damage occurred during shipping.
- Do not discard the packing material until you have carefully inspected and satisfactorily operated the tool.
- If any parts are damaged or missing, please call 1-800-444-3353 for assistance.

PACKING LIST

Air Compressor (1)
Operator's Manual (1)
Replacement Parts List (1)



WARNING:

If any parts are missing do not operate the compressor or air tools until the missing parts are replaced. Failure to do so could result in possible serious personal injury.



WARNING:

Do not attempt to modify this tool or create accessories not recommended for use with this tool. Any such alteration or modification is misuse and could result in a hazardous condition leading to possible serious personal injury.

ASSEMBLY

ASSEMBLING THE RUBBER FOOT AND WHEELS

See Figure 3.

- Mount the rubber foot as shown in figure. Tighten firmly with an open-end wrench (not included) to secure it in position.
- Mount the wheels as shown in figure. Tighten firmly with an open-end wrench (not included) to secure the wheels in position.

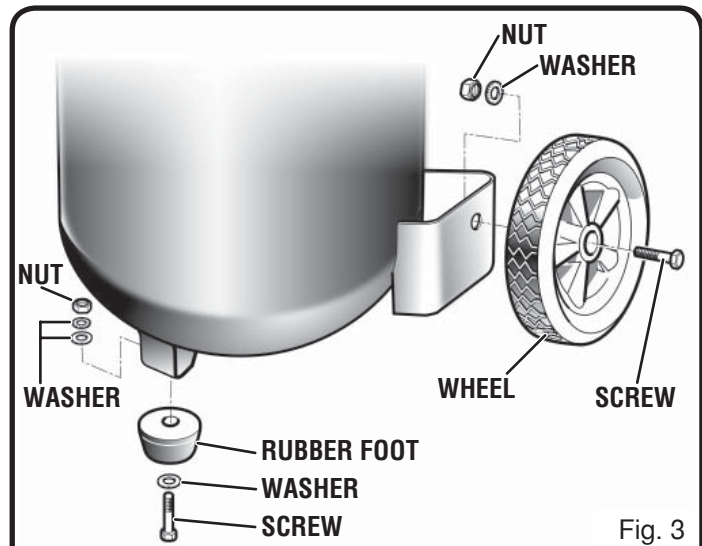

Fig. 3

FITTING THE AIR FILTER

See Figures 4 - 5 - 6.

- Remove the transportation stop with a screwdriver (or by means of other similar sharp tool) (Fig. 4 - 5).
- Screw the air filter securely to the equipment, by turning it clockwise (Fig. 6).

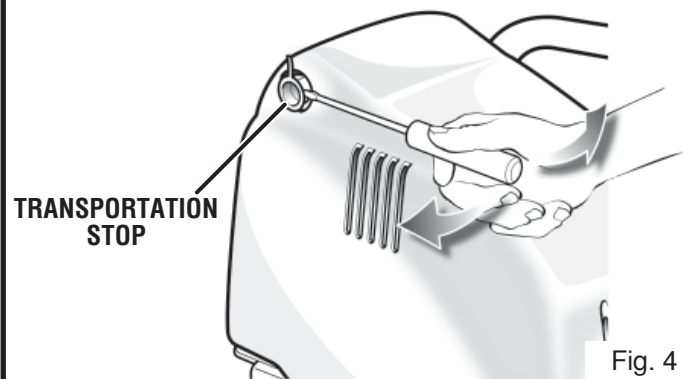

Fig. 4

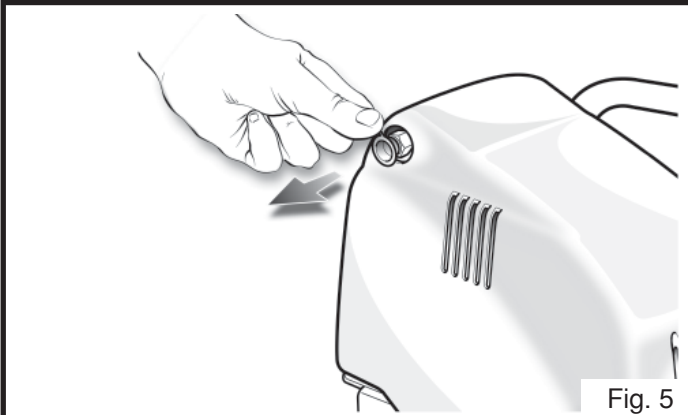

Fig. 5

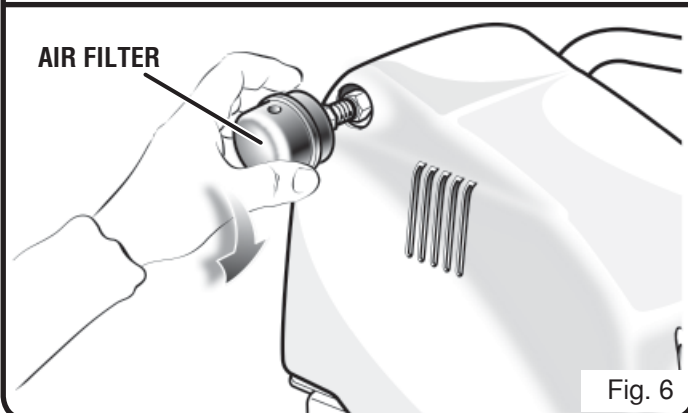

Fig. 6

ASSEMBLY

BREAKING IN THE PUMP

See Figures 7 - 8.

- Check and tighten all bolts, fittings, etc.
- Turn the pressure regulator knob fully clockwise to open the air flow.
- Press the red button of the On/Off switch and plug in the power cord.
- Open the drain valve completely.
- Pull out the red button of the On/Off switch and run the air compressor for 10 minutes to break in pump parts.
- Press in the red button of the On/Off switch.
- Close the drain valve.

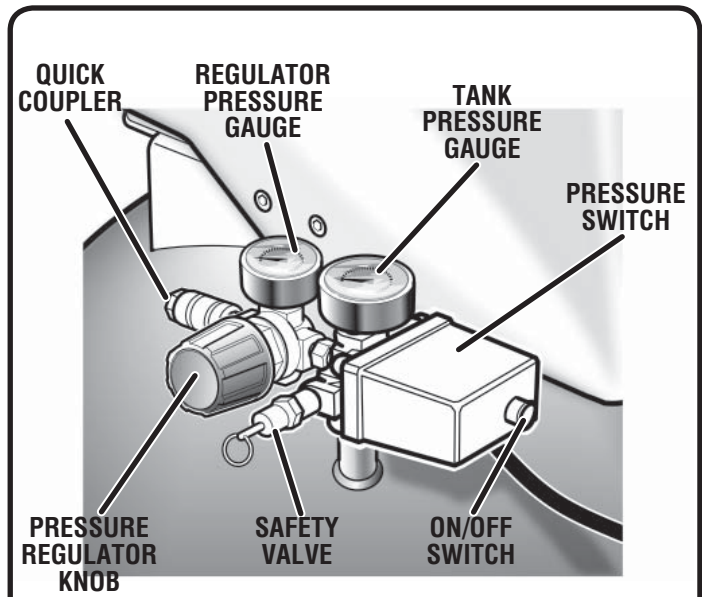

Fig. 7

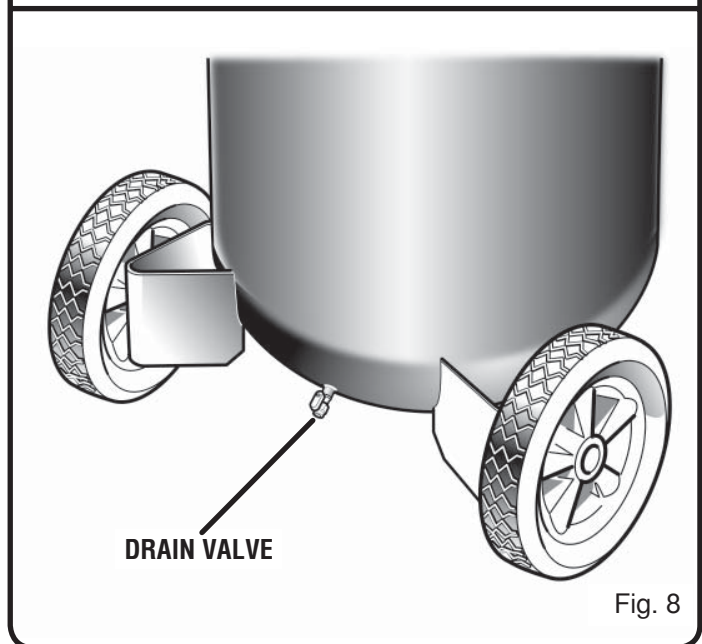

Fig. 8

OPERATION

WARNING:

Do not allow familiarity with tools to make you careless. Remember that a careless fraction of a second is sufficient to inflict serious injury.

WARNING:

Always wear safety goggles or safety glasses with side shields when operating power tools. Failure to do so could result in objects being thrown into your eyes resulting in possible serious injury.

CAUTION:

Do not use in an environment that is dusty or otherwise contaminated. Using the air compressor in this type of environment may cause damage to the unit.

APPLICATIONS

Air compressors are utilized in a variety of air system applications. Match hoses, connectors, air tools, and accessories to the capabilities of the air compressor.

You may use this tool for purposes listed below:

- Operating some air-powered tools.
- Inflating tires, air beds, sports equipment, etc.

USING THE AIR COMPRESSOR

See Figure 7.

- Ensure tank drain is closed.
- Ensure On/Off switch is in the **OFF** position and air compressor is unplugged.
- If not already installed, attach hose to compressor.

WARNING:

Always ensure the On/Off switch is in the OFF position and the regulator pressure gauge read zero before changing air tools or disconnecting the hose from the air outlet. Failure to do so could result in possible serious personal injury.

- Rotate regulator knob fully clockwise to open air flow.
- Connect the power cord to the power supply.
- Pull out the red button of the On/Off switch in order to switch on the compressor.
- Rotate pressure regulator knob to desired line pressure. Turning the knob clockwise increases air pressure at the outlet; turning counterclockwise reduces air pressure at the outlet.
- Following all safety precautions in this manual and the manufacturer's instructions in the air tool manual, you may now proceed to use your air-powered tool.

WARNING:

Your tool may require more air consumption than this air compressor is capable of providing. Check the tool manual to avoid damage to the tool or risk of personal injury.

- If using an inflation accessory, control the amount of air flow with the pressure regulator knob. Turning the knob fully counterclockwise will completely stop the flow of air.

NOTE: Always use the minimum amount of pressure necessary for your application. Using a higher pressure than needed will drain air from the tank more rapidly and cause the unit to cycle on more frequently.

- When finished, always drain the tank and unplug the unit. Never leave the unit plugged in and/or running unattended.

OPERATION

DRAINING THE TANK

See Figures 9 - 10.

To help prevent tank corrosion and keep moisture out of the air used, the tank of the compressor should be drained daily.

A correct use of the drain valve:

- Verify that the compressor is turned off.
 - Holding the handle, tilt the compressor toward the drain valve so that it's set in a lower position.
 - Open the drain valve completely.
 - Keep the compressor tilted (figure 10) until all moisture has been removed.
 - Drain moisture from tank into a suitable container.
- NOTE:** Condensate is a polluting material and should be disposed of in compliance with local regulations.
- If drain valve is clogged, release all air pressure by pulling the safety valve. Remove and clean valve, then reinstall.

WARNING:

Unplug the air compressor and release all air from the tank before servicing. Failure to depressurize tank before attempting to remove valve may cause serious personal injury.

- Turn off drain valve until completely closed.

CHECKING THE SAFETY VALVE

See Figure 11.

WARNING:

Do not attempt to tamper with safety valve. Anything loosened from this device could fly up and hit you. Failure to heed this warning could result in death or serious personal injury.

The safety valve will automatically release air if the air receiver pressure exceeds the preset maximum. The valve should be checked before each day of use by pulling the ring by hand.

- Turn the air compressor on and allow the tank to fill. The compressor will shut off when the pressure reaches the preset maximum.
- Turn the air compressor off.
- Pull the ring on the safety valve to release air for twenty seconds.
- Release the ring. Air must immediately stop escaping when the ring is released. Any continued loss of air after releasing the safety valve ring indicates a problem with the safety valve. Discontinue use and seek service before continued use of the air compressor.

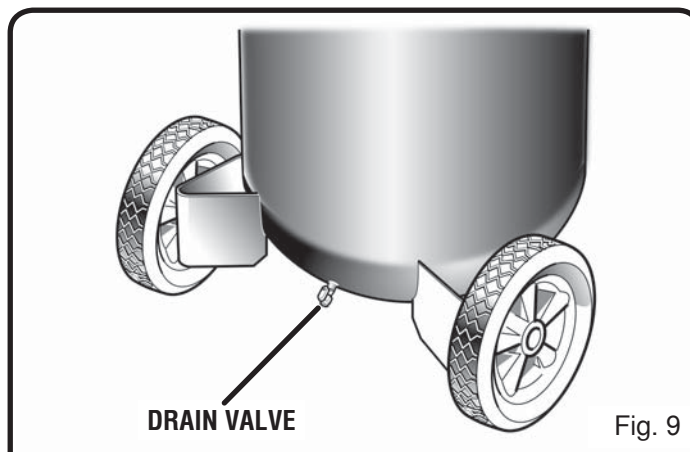

Fig. 9



Fig. 10

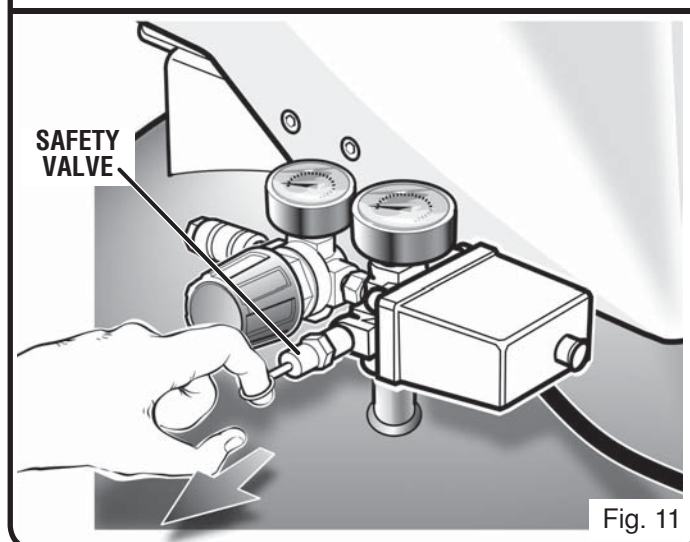

Fig. 11

WARNING:

If air leaks after the ring has been released, or if the valve is stuck and cannot be actuated by the ring, Do Not use the air compressor until the safety valve has been replaced. Use of the air compressor in this condition could result in serious personal injury.

MAINTENANCE

WARNING:

When servicing, use only identical Harbor Freight Tools replacement parts. Use of any other parts may create a hazard or cause product damage.

WARNING:

Always wear safety goggles or safety glasses with side shields during power tool operation or when blowing dust. If operation is dusty, also wear a dust mask.

WARNING:

Always release all pressure, disconnect from power supply, and allow unit to cool to the touch before cleaning or making repairs on the air compressor.

WARNING:

Do not at any time let brake fluids, gasoline, petroleum-based products, penetrating oils, etc., come in contact with plastic parts. Chemical can damage, weaken or destroy plastic which may result in serious personal injury. Electric tools used on fiberglass material, wall-board, spackling compounds, or plaster are subject to accelerated wear and possible premature failure because the fiberglass chips and grindings are highly abrasive to bearings, brushes, commutators, etc. Consequently, we do not recommend using this tool for extended work on these type of materials. However, if you do work with any of these materials, it is extremely important to clean the tool using compressed air.

GENERAL MAINTENANCE

Humidity in the air causes condensate to form in the air tank. This condensate should be drained daily and/or every hour, using the instructions found in **Draining the Tank**.

The safety valve automatically releases air if the air receiver pressure exceeds the preset maximum. Check the safety valve before each use following the instructions found in **Checking the Safety Valve**.

Inspect the tank yearly for rust, pin holes, or other imperfections that could cause it to become unsafe.

Avoid using solvents when cleaning plastic parts. Most plastics are susceptible to damage from various types of commercial solvents and may be damaged by their use. Use clean cloths to remove dirt, dust, oil, grease, etc.

LUBRICATION

All the bearings in this tool are lubricated with a sufficient amount of high grade lubricant for the life of the unit under normal operating conditions. Therefore, no further lubrication of the bearings is required.

CLEANING THE INTAKE FILTER

The intake filter prevents dust and dirt being drawn in. It is essential to clean this filter after at least every 100 hours in service. A clogged intake filter will decrease the compressor's performance dramatically. Remove the filter from the compressor and undo the thumb screw on the air filter. You can then remove the filter from the two halves of the plastic housing, tap it to remove the dirt, blast it down with low-pressure compressed air (approx. 3 bar) and re-insert it.

TROUBLESHOOTING

Problem	Possible Cause	Solution
Compressor will not run	Loss of power or overheating No electrical power Blown shop/house fuse Shop/house breaker open Thermal overload open Pressure switch bad Tank is full of air	Check for proper use of extension cord Check to be sure unit is plugged in Check fuse/breaker or motor overload Replace shop/house blown fuse Reset shop/house breaker, determining why problem happened Motor will restart when cool Replace pressure switch Compressor will turn on when tank pressure drops to cut-in pressure
Motor hums but cannot run or runs slowly	Low voltage Wrong gauge wire or length of extension cord Shorted or open motor winding Defective check valve or unloader	Check with voltmeter Check for proper gauge wire and cord length Take compressor to service center Take compressor to service center
Fuses blow/circuit breaker trips repeatedly	Incorrect size fuse, circuit overload Wrong gauge wire or length of extension cord Defective check valve or under loader	Check for proper fuse, use time-delay fuse, disconnect other electrical appliances from circuit or operate compressor on its own branch circuit Check for proper gauge wire and cord length Take compressor to service center
Thermal overload protector cuts out repeatedly	Low voltage Lack of proper ventilation/room temperature too high Wrong gauge wire or length of extension cord	Check with voltmeter Move compressor to well-ventilated area Check for proper gauge wire and cord length
Air receiver pressure drops when compressor shuts off	Loose connections (fittings, tubing, etc.) Loose drain valve Check valve leaking	Check all connections with soap and water solution and tighten Tighten drain valve Take compressor to service center <div style="border: 1px solid black; padding: 5px; margin-top: 10px;"> <p> DANGER: Do not disassemble check valve with air in tank — bleed tank.</p> </div>
Excessive moisture in discharge air	Excessive water in air tank High humidity	Drain tank Move to area of less humidity; use air line filter
Compressor runs continuously	Defective pressure switch Excessive air usage	Take compressor to service center Decrease air usage; compressor not large enough for tool's requirement
Compressor vibrates	Loose mounting bolts	Tighten mounting bolts
Air output lower than normal	Broken inlet valves Connections leaking	Take compressor to service center Tighten connections

90 Day Warranty

Harbor Freight Tools Co. makes every effort to assure that its products meet high quality and durability standards, and warrants to the original purchaser that this product is free from defects in materials and workmanship for the period of 90 days from the date of purchase. This warranty does not apply to damage due directly or indirectly, to misuse, abuse, negligence or accidents, repairs or alterations outside our facilities, criminal activity, improper installation, normal wear and tear, or to lack of maintenance. We shall in no event be liable for death, injuries to persons or property, or for incidental, contingent, special or consequential damages arising from the use of our product. Some states do not allow the exclusion or limitation of incidental or consequential damages, so the above limitation of exclusion may not apply to you. This warranty is expressly in lieu of all other warranties, express or implied, including the warranties of merchantability and fitness.

To take advantage of this warranty, the product or part must be returned to us with transportation charges prepaid. Proof of purchase date and an explanation of the complaint must accompany the merchandise. If our inspection verifies the defect, we will either repair or replace the product at our election or we may elect to refund the purchase price if we cannot readily and quickly provide you with a replacement. We will return repaired products at our expense, but if we determine there is no defect, or that the defect resulted from causes not within the scope of our warranty, then you must bear the cost of returning the product.

This warranty gives you specific legal rights and you may also have other rights which vary from state to state.

3491 Mission Oaks Blvd. • PO Box 6009 • Camarillo, CA 93011 • (800) 444-3353

WARNING: The brass components of this product contain lead, a chemical known to the State of California to cause birth defects (or other reproductive harm). (California Health & Safety code § 25249.5, et seq.)

For technical questions, please call 1-800-444-3353.

REV 11h